

July 12, 1949.

C. N. CORYELL
CIGARETTE LIGHTER

2,475,659

Filed Aug. 9, 1945

Fig. 1.

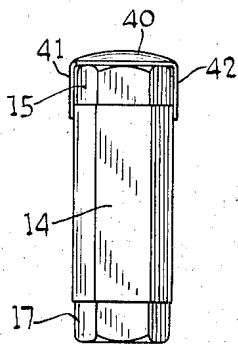

Fig. 2.

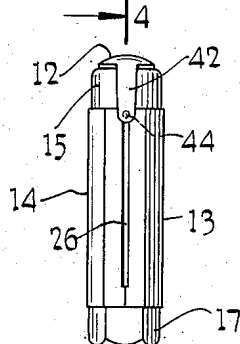

Fig. 3.

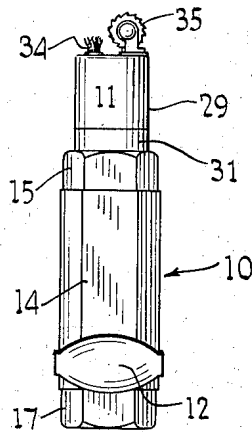

Fig. 6.

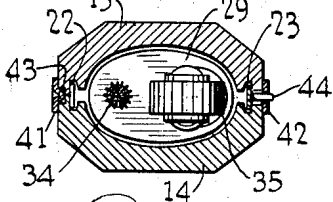

Fig. 7.

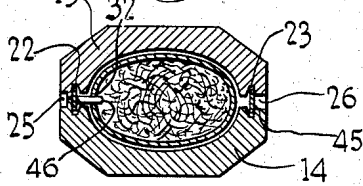

Fig. 8.

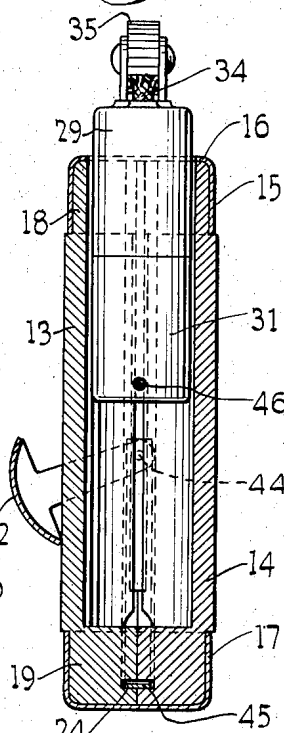

Fig. 5.

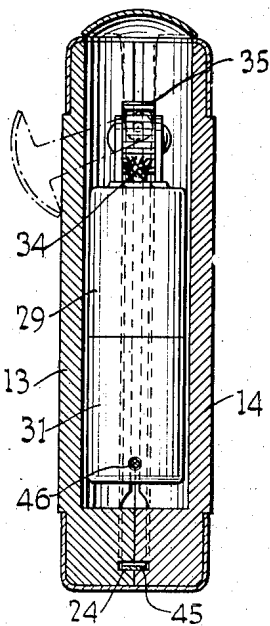
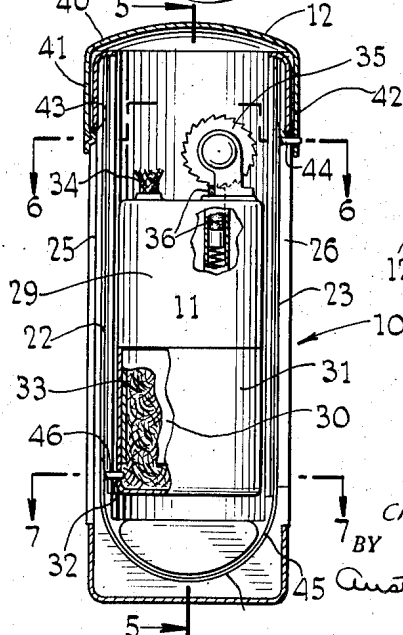

Fig. 4.



INVENTOR.
CHARLES N. CORYELL
BY
Austin, Wilhelm & Carlson
ATTORNEYS

UNITED STATES PATENT OFFICE

2,475,659

CIGARETTE LIGHTER

Charles N. Coryell, New Rochelle, N. Y.; Frances C. Coryell, administratrix of said Charles N. Coryell, deceased, assignor to Robert L. Coryell, New Rochelle, N. Y.

Application August 9, 1945, Serial No. 609,779

3 Claims. (Cl. 67-7.1)

1

The invention relates to cigarette lighters and more particularly to a casing for holding and protecting the lighter.

According to a preferred form of the invention, the lighter comprises a tubular case in which the lighter unit is slidably mounted. The case has a removable cover which is connected to the lighter unit in such manner that by removing the cover the lighter unit automatically advances out of the casing to such position that the lighter wheel may be operated. The cover may be used to retract the lighter unit within its case to provide a compartment, protected from the wind, in which the cigarette might be inserted for lighting. Replacement of the cover on the case automatically retracts the lighter unit and snuffs out the flame.

The invention also consists in certain new and original features of construction and combinations of parts hereinafter set forth and claimed.

Although the novel features which are believed to be characteristic of this invention will be particularly pointed out in the claims appended hereto, the invention itself, as to its objects and advantages, and the manner in which it may be carried out, may be better understood by referring to the following description taken in connection with the accompanying drawings forming a part hereof, in which:

Fig. 1 is a front elevation of the lighter according to the invention, in closed position;

Fig. 2 is a side elevation of the lighter in closed position;

Fig. 3 is a front elevation of the lighter in fully open position;

Fig. 4 is an enlarged longitudinal vertical section on the line 4-4 of Fig. 2;

Fig. 5 is an enlarged vertical section on the line 5-5 of Fig. 4;

Figs. 6 and 7 are transverse sections on the line 6-6 and 7-7 respectively of Fig. 4; and

Fig. 8 is an enlarged vertical section, with the lighting unit advanced in one position in which it may be used in practice.

In the following description and in the claims, various details will be identified by specific names for convenience, but they are intended to be as generic in their application as the art will permit. Like reference characters denote like parts in the several figures of the drawings.

In the drawings accompanying and forming part of this specification, certain specific disclosure of the invention is made for purposes of explanation, but it will be understood that the details may be modified in various respects with-

2

out departure from the broad aspect of the invention.

Referring now to the drawings, the lighter comprises in general a tubular case 10, lighter unit 11 slidably therein, and removable cover 12. The cover is shown in closed position in Figs. 1 and 2. The lighter may be moved to open position simply by swinging open the cover and sliding it down to the position indicated in Fig. 3 or 8, as will be apparent from the following description.

The case 10 may comprise two halves or sections 13 and 14 which may be of suitable molded material, such as plastic. These halves are held together by a top annular band 15 having an inward rounded edge 16 and a bottom closed cup 17. The top band or collar 15 surrounds a reduced portion 18 which forms a shoulder with the body of the casing halves 13 and 14. The bottom cup 17 surrounds a reduced portion 19 which also forms a shoulder with the casing halves. These top and bottom bands 15 and 17 are held in position by a tight fit with the casing halves 13, 14, or by cement, or in any suitable manner, to make in effect an integral operating unit of the two casing halves 13 and 14 and the top and bottom bands 15 and 17.

The case 10 may be of any suitable or desirable shape. In the form shown the interior is generally oval while the exterior is octagonal in transverse cross section.

As part of the operating mechanism whereby the movement of the cap 12 operates the lighter unit 11, the casing halves 13, 14 have straight channels 22 and 23 on either side molded therein and curved channels 24 at the bottom, these channels being formed in the meeting faces of both casing halves and complementing each other to form a bandway for flexible operating band 45. The outer wall of the case 10 has shallow pin-way 25 and a deeper pin-way 26 also formed in both casing halves.

The lighter unit 11 comprises an upper body member 29 having a reduced tubular extension 30 on which is mounted a removable bottom member 31. Body 29 and bottom member 31 provide a hollow casing in which is disposed suitable absorbent material 33 for holding the lighter fluid, as will be understood by those skilled in the art.

The lighter body 29 also supports the usual wick 34, ribbed wheel 35 and rod 36. As is well understood, when the wheel is rotated by the finger, its rubbing action against the rod 36 generates a shower of sparks which ignites wick 34.

The cover 12 comprises a crowned cap 40 having depending arms 41 and 42. Arm 41 has an

3

indented portion forming a short pintle 43 which rides in shallow pin-way 25. Arm 42 has an opening which receives long pin 44 which rides in deep pin-way 26 and which is rigidly secured to the end of operating band 45. The other end of operating band 45 has rigidly secured thereto a pin 46 positioned in hole 32 in removable lighter bottom 31.

The under surface of cap 40 is rounded to cooperate with the rounded inturned edges 16 of top band 15. The pintles 43 and 44 are so located with respect to top band 15 that the cover 40 resiliently seats on the open top of case 10. However, the cap 12 may be rotated about its pintles, with application of slight pressure by the thumb, to the position shown in dotted lines in Figure 5 after which it may be slid down the outside of the casing with the pintles 43, 44 riding in grooves 25, 26. This movement causes the operating band 45 to slide in bandways 22, 23, 24 pushing the lighter unit 11 upwardly until, when the cover 12 takes a position near the lower end of the case as indicated in Figure 3, the lighter unit 11 is projected pretty well out of the casing.

Ordinarily it is sufficient to project the lighter unit 11 only out to some position such as indicated in Figure 8 where it is convenient to twirl the wheel 35 by the thumb to ignite wick 34. The cigarette may be lighted immediately with the lighting unit in this position or, if there is a high wind blowing, the lighter unit may be retracted to a position partly within the case 10 where the flame is protected from the wind and the cigarette may be inserted into the case to light it. Figure 5 indicates such a position of the lighter unit, the open position of the cover 12 being indicated by dot-and-dash lines.

The lighter is closed by slidably moving the cover 12 back up to the top of the case and rotating it to closed position, which action will snuff out the lighter if it has not already been blown out by the user.

To replenish the lighter with fuel, the lighting unit 11 will be advanced all the way out to the position shown in Figure 3. In this position the lighter body 29 may be easily removed from the bottom cover 31, which it engages telescopically with a snug friction fit. The lighter body 29 will be exposed at its lower end and the absorbent material 33 carried thereby will then be saturated with the usual lighter fluid after which the lighter body 29 will be replaced by inserting it into the bottom cover 31.

Thus a cigarette lighter is provided which is inexpensive to manufacture and most convenient and safe to use. It is opened and advanced by a simple rotative and sliding movement of the cover by the thumb and closed the same way. The lighter wheel can be spun by the same thumb that opens the cover so that the lighter may be opened, lighted, used and closed in a single manipulation of the fingers of one hand. The cover is always attached so it cannot get lost and is available for automatically snuffing out the

4

lighter when the lighter is closed. The ability to retract the lighter within the lighter body before completely closing facilitates lighting a cigarette in high winds. The U-shaped band and bandway insures ease of operation. The plastic case halves and top and bottom rings facilitates manufacture of the case.

While certain novel features of the invention have been disclosed herein, and are pointed out in the annexed claims, it will be understood that various omissions, substitutions and changes may be made by those skilled in the art without departing from the spirit of the invention.

What is claimed is:

1. In a cigarette lighter, a case, a cap for said case, a lighter unit slidable within said case, said case having a U-shaped bandway, a band in said bandway having one end connected to said unit and the other end connected to said cap whereby opening movement of said cap advances said unit, said unit being retractible within said case while said cover remains open to protect the lighter flame by the surrounding case wall.

2. A cigarette lighter comprising a case having a U-shaped bandway, a lighter unit in said case, a band in said bandway, said case having longitudinal pin-ways, a cap having a top wall with depending arms, one arm having a pivot riding in one pin-way, the other arm having a pivot riding in said other pin-way and connected to one end of said band, the other end of said band being connected to said lighter unit.

3. A cigarette lighter comprising a case, a lighter unit slidable within said case, said case having two longitudinally separable sections, a lower cap and an upper collar both snugly surrounding said sections to hold the same together, said sections at their meeting edges having a U-shaped bandway, a band in said bandway, said sections having at their meeting edges an external shallow pin-way and an external deep pin-way, a cap having a top wall with depending arms, one arm having a pivot riding in said shallow pin-way, the other arm having a pivot riding in said deep pin-way and connected to one end of said band, the other end of said band being connected to said lighter unit.

CHARLES N. CORYELL.

REFERENCES CITED

The following references are of record in the file of this patent:

UNITED STATES PATENTS

Number	Name	Date
1,045,683	Danicek	Nov. 26, 1912
1,820,131	Fischer	Aug. 25, 1931
2,092,574	Silberknopf	Sept. 7, 1937

FOREIGN PATENTS

Number	Country	Date
739,640	France	Nov. 3, 1932
801,928	France	May 30, 1936